

# AlfaSpid Rotator and Controller

# Instruction Manual



**This manual is for use with units sold by AlfaRadio Ltd. of Edmonton, Alberta, Canada. Units sold by others may have different firmware and may operate from different voltages.**

Last updated on September 08 2008

Copyright AlfaRadio Ltd 2002-2008 2008-01-15

[www.alfaradio.ca](http://www.alfaradio.ca) 780.466.5779

# Table of Contents

Introduction .....	4
Shipping Contents.....	4
Technical Data .....	4
Control Panel .....	5
Rear Panel .....	6
Installation .....	7
Bench Testing.....	8
Resetting the Controller .....	9
Controller Operation.....	10
Function Mode.....	10
Normal Operations Mode .....	11
Half Auto Mode.....	11
Auto Mode .....	11
Preset Mode .....	11
Setup Mode .....	12
Programable High Limit.....	12
Programmable Low Limit.....	13
Programmable Reset Value .....	13
Preset 1 - 6.....	13
Mouse Controller.....	15
Using the AlfaSpid Rotator with LONG Cable Distances .....	18
Warranty .....	21
Notes.....	22

**This manual is for use with units sold by AlfaRadio Ltd. of Edmonton, Alberta, Canada. Units sold by others may have different firmware and may operate from different voltages.**

Last updated on September 15, 2008

# Introduction

The AlfaSpid rotator is an extra heavy-duty rotator designed to run large communication antennas and comes complete with an electronic control unit. The rotator is designed to be mounted pipe to pipe or on an optional adaptor plate for conventional in tower mounting. It can also be mounted outside of the tower on the mast, or used in a side mount configuration.



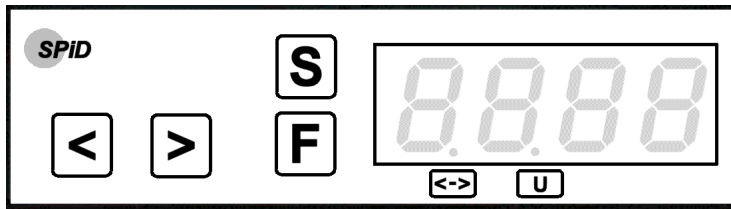

# Shipping Contents

Rotator .....	1
Controller.....	1
.....	1
GMA Fuses .....	2
Optional	
Custom Mouse .....	1



# Control Panel



## Buttons

-  -Left (Decrease)
-  -Right (Increase)
-  -Setup
-  -Function

## Indicators

-  -Overlap
-  -Not currently used

## 7 segment 4-digit display

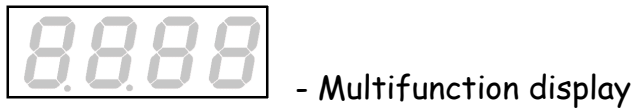

# Rear Panel

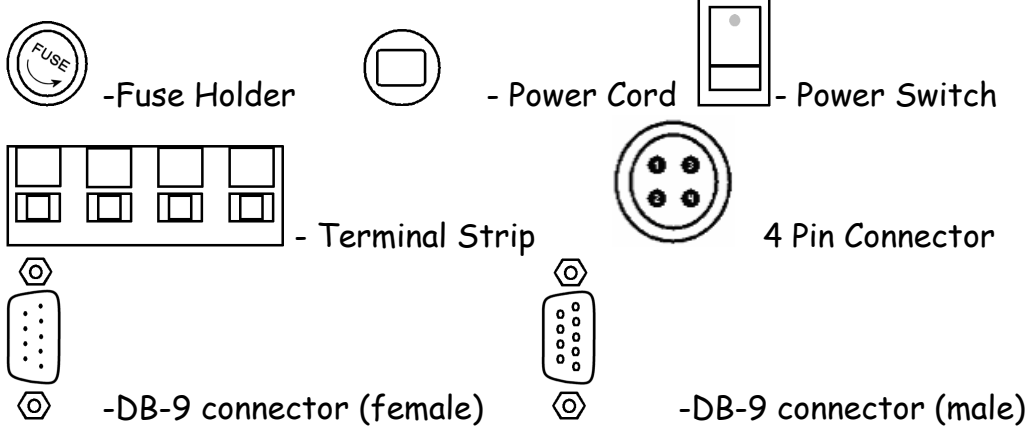
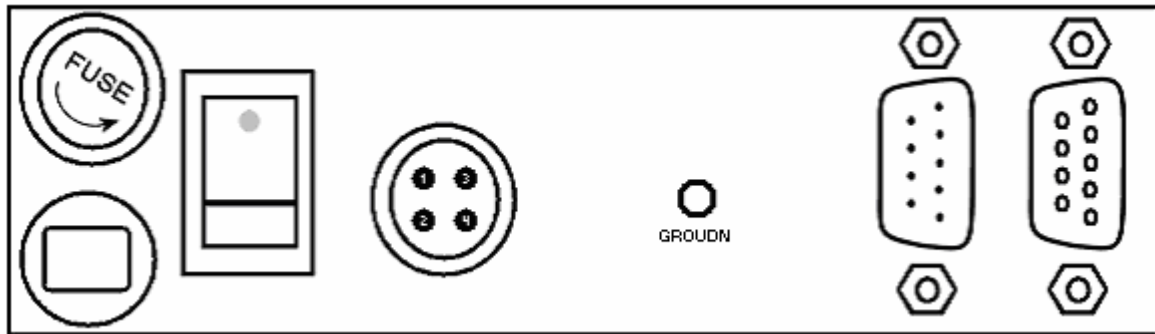
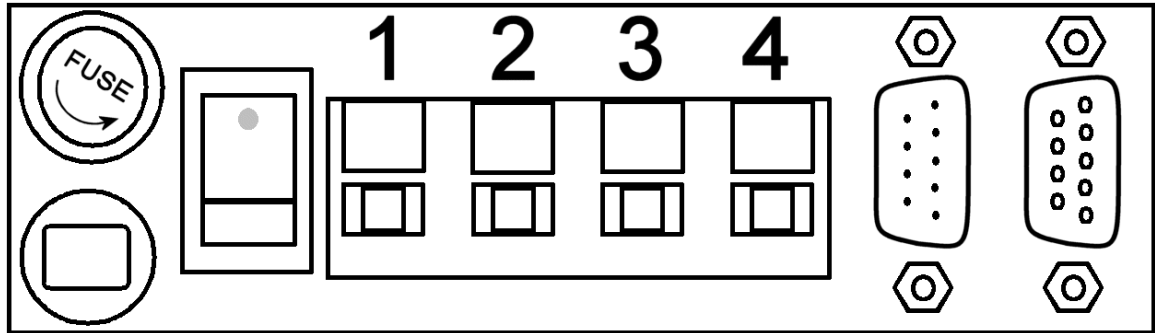

Female for CPU / RS232

Male for AlfaSpid Mouse

# Installation

## Wiring Connections

The rotator unit must be wired to the control unit with 4-wire cable. The gauge of the 4-wire cable to connect the control unit to the rotator depends upon the distance between rotator and controller. The wire for the impulse sensing may be quite thin - #22 or similar, even for relatively long distances.

<u>Length</u>	<u>Gauge Motor</u>
10 m (32')	#18 (1.19 mm)
30 m (100')	#16 (1.42 mm)
60 m (200')	#14 (1.75 mm)



### CAUTION!:

Do not accidentally switch the motor wires with the impulse wires. Damage to the control unit may occur!

Remove cover from the motor body as shown and make connections as follows:

- 1 Motor Drive to 1 on controller terminal
- 2 Motor Drive to 2 on controller terminal
- 3 Impulse Sense to 3 on controller terminal
- 4 Impulse Sense to 4 on controller terminal

We suggest that the coax from the antenna be made with extra length to allow for the "Over Travel" 720 degrees in total. You may wish to also allow for the coax to come off the "South" side of the tower ( 180 degrees ).

## Bench Testing of Control Box

The control box is normally expected to be operated from a 12 Volt DC supply; however it may be operated from other unregulated DC or AC sources as well. DC or AC voltage levels between 10 and 26 Volts capable of at least 5 Amps are acceptable, typically 12 or 14 Volts.



The polarity of the power to the control box input leads is not critical for D.C. operation; a diode rectifier on the input will provide the proper polarity to the electronics and provide reverse polarity protection as well as A.C. operation.

**TIP:** Because of several steering diodes in the motor path, the voltage delivered to the motor (neglecting wire loss) will be about 1.4 volts less than the power supply voltage. For longer runs and/or thin wiring a higher voltage (up to approx 24V) to the control unit is beneficial. A simple way to estimate if the voltage to the motor is adequate is by timing the rotation. Under no or a very small load, the 360 degree rotation time with 12V DC at the motor is about 120 second (2 minutes). With 24 V DC is about 60 second (1 minute). A DC Ammeter in the motor lead is also useful, it should indicate between 1 and 3 amps with a small load. On windy days or heavy load, the current may fluctuate up to 3 to 5 amps.

### Notes – testing and troubleshooting



It is highly recommended to ground the Control Box.

Pressing  should make the rotator move clockwise. Pressing  should make the rotator move counter-clockwise. If rotation is reversed, switch lines 1 and 2 on the back of the controller.

Impulse sense lines (3 & 4) have no polarity concerns.

Part of the protection circuitry involves removing motor power if the controller receives no sense indication. If the motor turns for a few seconds and then you hear the relay in the control box drop out, the motor has either stalled or there is a problem in the impulse sense wiring.

## Resetting the Controller

Since there are no mechanical limits in the rotator, it may be installed with the antenna pointing in any direction. There is no reason to locate "TRUE NORTH" until you are ready to calibrate the control box. Use the controller to position the antenna to physically point north, then reset the controller as follows:

Turn the unit OFF. Then while holding the **F** button depressed turn control unit back on. This will now show **8880** on the display. The controller is now set for North.

### Display adjustment:

Press the **S** button to cycle thru to the normal (i.e. blank) setting until you see the display after P5 X, (X is the mode for computer interface) It will be blinking. The display shows the normal degree reading i.e. 30 degrees, with the left or right arrows the display reading can be changed with out turning the rotator in this mode, this feature can be used if, for any reason, the direction of the antenna becomes incorrect. This may be caused by antenna to mast slippage or incorrect initial alignment. The Rotator to mast will not slip unless there is improper installation. See Heading Adjust (numbers blinking) else where in this document.

### IMPORTANT:

The AlfaSpid rotator is now set at the counter-clockwise end of its normal rotation range. Normal rotation range is in a clockwise direction for 360 degrees.

From the reset position, you can rotate counter-clockwise an additional 180 degrees in over-travel, as well 360 degrees clockwise, plus an additional 180 degrees into clockwise over-travel.

Counter-clockwise over-travel is indicated by a steady dot above the over-travel icon. **<->** Rotation past 359 degrees into the clockwise over-travel is indicated by a blinking dot above the over-travel icon. **<->**

Technical Note:







# Controller Operation

You will need to leave sufficient coax length to accommodate the additional 180 degrees of over-travel on each end of normal rotation. Failure to do so can cause damage to your coax and/or antennas.

The AlfaSpid controller has multiple modes of operation. You will need to become familiar with these modes to be able to make full use of your rotator.



## **F** Function Mode

The **F** button steps through the function menus. The leftmost character on the display indicates the function mode you are currently in.



-  Normal Operations Mode
-  Half Auto Mode
-  Auto Mode
-  Preset Mode

 The 0 in the displays to the left will be replaced by your actual beam heading



 - Normal Operations Mode

In Normal Operations Mode, the  and  buttons cause rotation as long as the buttons are pressed. Pressing  while in normal operations mode will take you to setup mode.



 - Half Auto Mode

In Half Auto Mode, the  and  buttons can be used to pre-select the desired beam heading. The heading displayed on the controller will rapidly change in the direction of desired rotation. Once the desired beam heading is shown on the display, release the key. Approximately ½ of a second after no key presses have been detected, the display will revert back to the actual beam heading, and rotation towards the desired heading will take place. Pressing any key while in transit to the desired heading will cancel the action.

 - Auto Mode

In Auto Mode, the controller will respond to commands from control software running on an attached computer. The  and  buttons can still be used as a manual override.











 - Preset Mode (requires optional mouse)

In Preset Mode, the  and  buttons cause rotation as long as the buttons are pressed. With the optional mouse attached, the six preset buttons can be used to select a desired beam heading. Preset beam heading values are set in Setup Mode



## **S** Setup Mode

The **S** button steps through the setup menu. The display cycles through each of the setup menu items.

**1.00** or **0.50** ratio setting ( Default is **1.00** )



-  - Programmable High Limit Default flashing "DOT" 180
-  - Programmable Low Limit Default not flashing "DOT" 180
-  - Programmable Reset Value 0 or 180
-  - Preset 1
-  - Preset 2
-  - Preset 3
-  - Preset 4
-  - Preset 5
-  - Preset 6
-  - Program Simulation
-  - Heading Adjust (numbers blinking)

### - Programmable High Limit

The Programmable High Limit is a user adjustable clockwise travel limit value. By reducing this value, the maximum clockwise rotation travel can be restricted. Use the  and  buttons adjust the value.

These limits can be used when side mounting the rotor to keep the antenna from colliding with the tower.

 - Programmable Low Limit

The Programmable Low Limit is a user adjustable counter-clockwise travel limit value. By increasing this value, the minimum counter-clockwise rotation travel can be restricted. Use the  and  buttons adjust the value.

 - Programmable Reset Value

The Programmable Reset Value can be set to either 0 degrees, or 180 degrees. This is the beam heading set when a power on reset event is triggered. If you wish to reset your rotator to south, set this value to 180.

 - Preset 1

P1 Thru P6

 - Preset 6

These 6 presets are user adjustable values that map to the 6 preset buttons on the optional mouse controller. You can set each preset to a commonly used beam heading, allowing rapid single button heading selections.

**8585** - Program Simulation

Program Simulation allows the user to set the serial communication protocol used by the rotator. When set to emulate another brand of rotator, the AlfaSpid will respond to commands, and send responses back to the computer as if it were the rotator brand selected. If your favourite software supports a rotator, chances are, the AlfaSpid will be able to interface to your software. There are 4 modes available: Note: some programs may not support the 1200 Baud requirements of the controller in emulation mode.



**8585** - Spid ( AlfaSpid ) Recommended**8580** - Orion**8584** - Hygain**8584** - Yaesu**8880** - Heading Adjust (numbers blinking)

This setting can be used to make minor heading adjustments without causing the rotator to turn. If you notice that the heading displayed on the controller to a known signal source is out by a few degrees, you can change the heading displayed on the LED readout to match the known heading, rather than having to turn back to North and reset the controller.

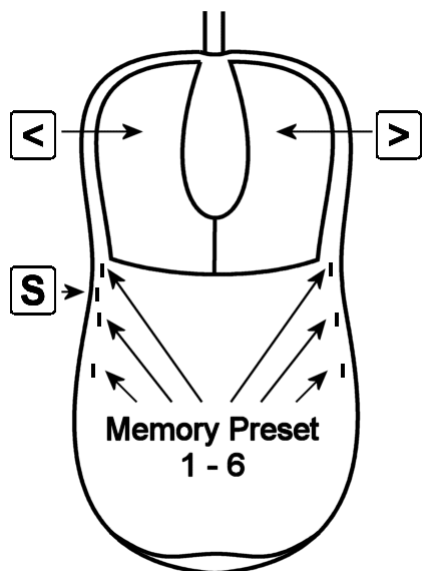
## Mouse Controller (Optional)



The optional mouse controller allows easy desktop access to the most commonly used front panel controls. These buttons are functionally equivalent to the corresponding front panel controls.

-  - Left (Decrease)
-  - Right (Increase)
-  - Stop ( also the wheel between left and right buttons )

 The mouse controller is a highly modified computer mouse. You can not use a regular mouse with the AlfaSpid

In addition to the above controls, you will find 6 programmable preset buttons on the mouse. Programmable preset buttons are only available via the optional mouse controller. Preset headings are programmed via the Setup Mode

The mouse ball serves no function; the mouse simply provides an ergonomically pleasing case in which to mount the controls.

## Alfa Radio Ltd. Trouble shooting tips

Before contacting AlfaRadio Ltd. Please make the following tests:.

The following are some trouble shouting tips, if for some reason your AlfaSpid will not operate correctly.

It is important to confirm correct operation before installing on the tower. This will rule out any damage that may have been caused by the shipping company.

Check the Limits - PH and PL settings and rule out overlap.

Simple resistance tests can reveal incorrect or shorted wiring.

Pins 1 and 2 are the motor winding and will have a low resistance. Typical 2 - 3 ohms.

Pins 3 and 4 are the sense lines and typically will have either an open circuit or have about 1200 ohms depending on the status of the reed switch in the rotator and the length and gauge of used wire.

There should be no conductivity between 1 and 3 or 1 and 4, or between 2 and 3 or 2 and 4

All lines should have **no** conductivity to ground.

**Be careful not to over wind your coax with the next test, as there will be no protection from over turning.**

Find a small 12 volts supply which will deliver 3 to 4 amps. ( a small 12 Volt battery will work just fine )

To confirm that the motor runs you may connect 12 volts D.C. to the lines that go to the motor, pins 1 and 2, it should turn. Reversing the 12 Volts D.C. should cause the motor to turn in the reverse direction.

To confirm that the sense circuit in the rotator is working, connect an ohm meter to the senses lines pins 3 and 4, apply 12 volts to the motor lines pins 1 and 2; you should see the ohm meter reading alternate between open circuit and about 1200 ohms.

Pin on Rotator not controller	Typical Reading	Your reading	
Pins 1 to 2	About 2 to 4 Ohms	_____	Depends on the length of wire to rotator
Pins 3 to 4	Open or 1200 Ohms	_____	Depends on the status of the read switch
Pins 1 to 3	Open	_____	
Pins 2 to 3	Open	_____	
Pins 2 to 4	Open	_____	
Pin 1 to Ground	Open	_____	
Pin 2 to Ground	Open	_____	
Pin 3 to Ground	Open	_____	
Pin 4 to Ground	Open	_____	
Voltage on controller			
Pins 1 to 2	About 12 volts with motor running		Depends on the supply voltage (14 volt applied)
Pins 3 to 4	About 8.5 volts or 2.5 volts *		Depends on the status of the read switch and the Supply voltage



## Using the *AlfaSpid Rotator* with LONG Cable Distances By VE6JY

Since the motor uses relatively low voltage DC, a combination of long cable runs and/or thinner than required cable may reduce the voltage at the motor to an unacceptably low value. It may turn in warm weather or light winds but the power will not be available to rotate under more severe conditions.

While it is easy to say just use a heavier cable, this may be costly, impractical or both. I have one tower that is over 1700 feet (approx 500 meters away) and running large cable out there would be very expensive.

My solution is to use this rotator controller's output voltage to control another set of relays that will feed a higher voltage DC to the motor. In the above-mentioned example, I find a voltage between 60 to 80 volts gave suitable performance. This is a pretty extreme case but it illustrates the versatility of this design. The external DC supply voltage needed will vary depending on the DC voltage rating of your motor, the cable size and length of the run. Typically 36 to 50 volts at 3-5 amps should be quite adequate. These DC motors are quite tolerant on their voltage ratings.

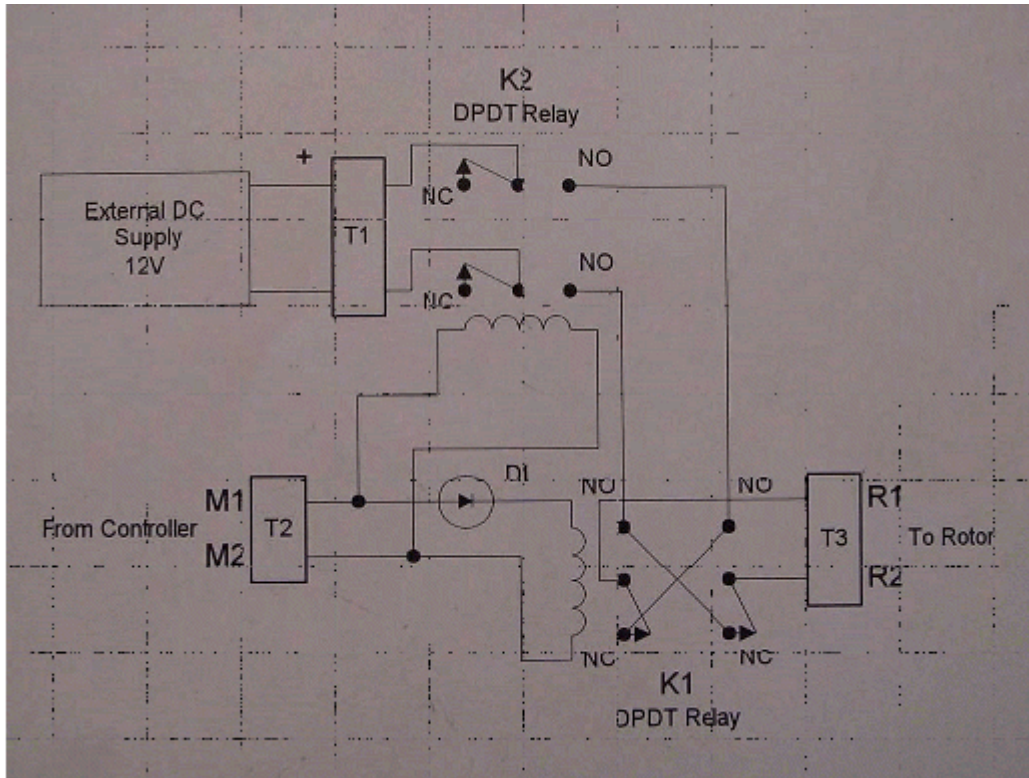

Relay Board Schematic

Relays chosen should be suitable for the proper coil voltage as well as appropriate current carrying capability. A relay capable of 5 to 10 amps DC is adequate. The diode in series with Relay K1 is any general purpose 1 amp style such as the 1N400x series. If the motor rotates incorrectly, simply reverse the leads to the motor or from the External DC Supply.

The controller also has the capability to, with a small modification, allow you to input your external DC voltage into the unit and use the internal relays to control the rotator as usual.



This information is presented as a guide to help the user realize a solution to the long cable run situation.

If you do not feel comfortable wiring basic circuitry to do this, please contact Alfa Radio Ltd. ([www.alfaradio.ca](http://www.alfaradio.ca)) for a pre-wired solution.

Prepared for Alfa Radio Ltd by VE6JY Don Moman Dec 6/2001

## 12 MONTH LIMITED WARRANTY

### AlfaSpid Rotator and controller

Alfa Radio Ltd. Warrants to the user, who originally purchased the product, that the product will be free from defects in material and workmanship for the following periods after such date of purchase: Material, 12 months : Workmanship, 12 months.

Alfa Radio Ltd. will, at its option, repair or replace free of charge such defective products subject to the following conditions:

1. Delivery of the product prepaid to Alfa Radio Ltd. or its authorized dealer.
2. Determination by the Alfa Radio Ltd. that a defect exists and is covered by the limited warranty. Defects due to alteration, pinning the mast to the rotator, repair by an unauthorized person, misuse, accidental damage, lightning strikes, use of the equipment for purpose other than those for which it was designed, and the like, are NOT COVERED by this limited warranty. Repairs therefore will be subject to normal service charges.
3. Repairs and replacement parts are covered under this limited warranty only for the remaining term of the original limited warranty.
4. Under no circumstances is Alfa Radio Ltd. liable for consequential damages to person(s) or property by the use of this product.
5. Alfa Radio Ltd. reserves the right to make changes or improvements in design or manufacture or firmware without incurring any obligations to install such changes upon any of the product previously manufactured.

All claims of defect or shortage should be sent prepaid to:

Alfa Radio Ltd.  
11211 - 154 Street  
Edmonton, Alberta  
T5M 1X8  
CANADA

All shipments must be accompanied by the letter describing the problem in detail along with a copy of your proof-of-purchase.

Contact AlfaRadio for authorization be for shipping.

[www.alfaradio.ca](http://www.alfaradio.ca) 780 446 8958

WE SERVICE WHAT WE SELL



## Typical travel of the AlfaSpid Rotator

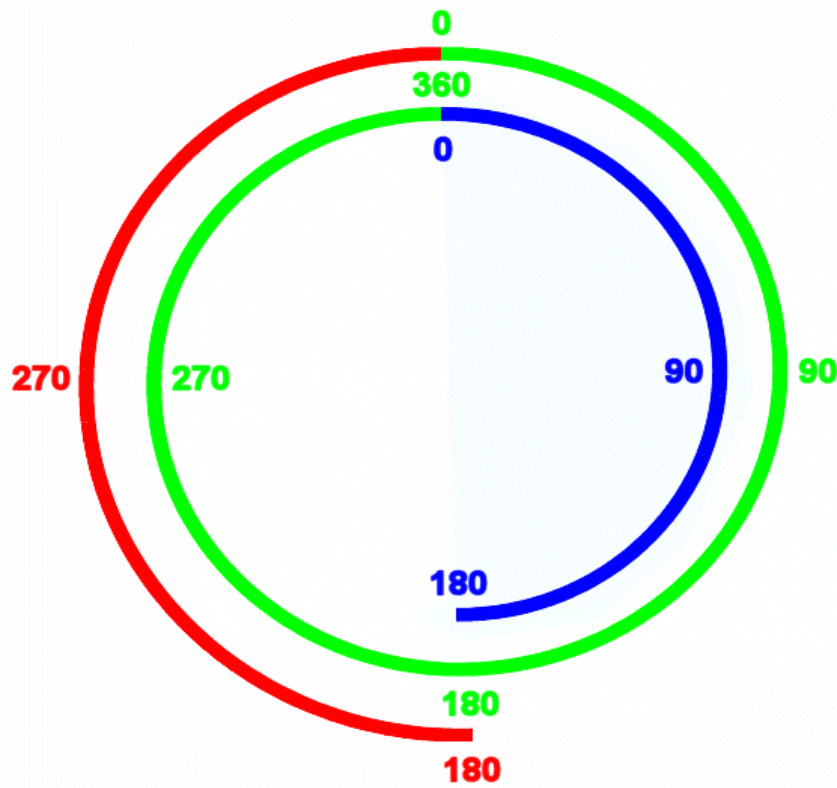

Blue 0 to 180 is the dot (not flashing) PH over travel (Right 180 side of diagram)

Red 0 to 180 is the dot(flashing) PL over travel ( Left 180 side of diagram)

# Technical Data

Input Voltage (Typical) ..... 13.8 – 24 Volts DC  
 Input Current (Nominal Draw) at 12 Volts with no or small load ..... 3 – 4 Amps  
 Motor ..... 12 – 24 Volts DC  
 Fuse ..... 8.0 Amp GMA

Specifications: AlfaSpid RAK Azimuth Rotator	RAK @ 12V	RAK @ 24V
Turning torque in lbs / N m	1,400 in lb / 158 N m	3,240 in lb / 366 N m
Brake torque in lbs / N m	14,000 in lb / 1,582 N m	14,000 in lb / 1,582 N m
Brake Construction	Double Worm Gears	Double Worm Gears
Vertical Load lbs / Kg	550 lbs / 250 Kg	550 lbs / 250 Kg
Rotation Speed (360 Deg)	120 sec	60 sec
Precision	1 deg	1 deg
Rotation Range	720 deg	720 deg
Weight lbs / Mass Kg	16 lbs / 7 Kg	16 lbs / 7 Kg
Position Sensor	Reed Switch	Reed Switch
Mast size top / bottom – in / mm	2.0 / 2.6 in, 50 / 66 mm	2.0 / 2.6 in, 50 / 66 mm
Specifications: AlfaSpid BIG RAK	BIG RAK @ 12V	BIG RAK @ 24V
Turning torque in lbs / N m	>5,000 in lb / 565 N m	Contact AlfaRadio
Brake Torque in lbs / N m	24,000 in lb / 2,712 N m	24,000 in lb / 2,712 N m
Brake Construction	Double Worm Gears	Double Worm Gears
Vertical Load lbs / Kg	>700 lbs / 318 Kg	>700 lbs / 318 Kg
Rotation Speed (360 Deg)	120 sec	60 sec
Precision	1 / 0.5 deg	1 / 0.5 deg
Rotation Range	720 deg	720 deg
Weight lbs / Mass Kg	24 lbs / 11 kg	24 lbs / 11 kg
Position Sensor	Reed Switch	Reed Switch
Mast size top / bottom – in / mm	2.6 / 2.6 in, 66 / 66 mm	2.6 / 2.6 in, 66 / 66 mm
Specifications: AlfaSpid controllers	When used with RAK or REAL 13.8 – 24 V AC or DC	When used with RAS or REAL 13.8 – 24 V AC or DC
Computer interface	RS 232 1200 baud 8 N 1	RS 232 600 baud 8 N 1
Pre sets with Mouse	6 User settable presets	N/A
Emulation	Spid, Hygain, Orion, Yaesu	Spid, Yaesu
Limit settings	2 – AZ CW point & CCW point	4 ( 2 AZ - 2 EL )
User settable calibration	N or S or any degree	AZ & EL, any degree
Precision	1 / 0.5 deg	1 , 0.5, 0.25 deg
Rotation Range	720 deg	360 / 180 - 180 deg
Weight lbs / Mass Kg	2.75 lbs / 1.2 Kg	4.75 lbs / 2.1 Kg
Connections to Rotator	4 wires ( 2 sens, 2 motor )	4 wires ( 2 sens, 2 motor ) EL 4 wires ( 2 sens, 2 motor ) AZ Total 8 wires RAS, 4 wires for REAL

**All specifications may change with out further notice and all values are approx.**